

## Features

### Range of modular DC power supplies

- High efficiency (up to 91%)
- Low (< 0.4 W) stand-by power absorption
- Thermal protection: internal, with  $V_{out}$  shutdown
- Short circuit protection: hiccup (auto-recovery) mode
- Input protection: replaceable internal fuse plus spare (78.36)
- Overvoltage protection: varistor
- Flyback topology
- Compliant to EN 60950-1 and EN 61204-3
- Parallel working for automatic redundancy: with OR-IN diode
- Dual and series connection permissible
- Small dimensions: 17.5 mm (1 module) or 70 mm (4-modules) wide, 60 mm deep
- 35 mm rail (EN 60715) mount

Screw terminal



For outline drawing see page 7

### NEW 78.12



• 24 V DC, 12 W output

### NEW 78.36



• 24 V DC, 36 W output

\* (see diagrams L78)  
 \*\* peak to peak, 100 Hz component, with 100 V AC input  
 \*\*\* 88...100 V AC with output current 80 %  $I_N$   
 \*\*\*\* (see derating diagrams P78)

Output specification		78.12	78.36
Output current (-20...+40°C, 230 V AC input) A		0.63	1.7
Rated current $I_N$ (50°C, full input operating range) A		0.50	1.5
Rated voltage V		24	24
Rated power W		12	36
Output power (-20...+40°C, 230 V AC input) W		15	40
Peak current capability for 3 ms * A		2	8
Output voltage adjust V		—	—
Voltage variation (from no-load to full-load)		< 1 %	< 1 %
Voltage ripple @ full load ** mV		< 200	< 200
Hold-up time@full load: with 100 V AC input ms		< 10	< 20
	with 260 V AC input ms	< 90	< 100
Input specification		78.12	78.36
Nominal voltage ( $U_N$ )	V AC (50/60 Hz)	110...240	110...240
	V DC (not polarized)	220	220
Operating range	V AC (50/60 Hz)	100...265***	100...265***
	V DC	140...370	140...370
Max power absorption (@ 100 V AC, 50 Hz)	VA	28.2	57.5
	W	14.2	43
Stand-by power absorption W		< 0.4	< 0.4
Power factor		0.50	0.74
Max current absorption (@ 88 V AC) A		0.25	0.6
Max. inrush current (peak @ 265 V) for 3 ms A		10	12
Replaceable protection fuse		—	1 A - T
Technical data		78.12	78.36
Efficiency (@ 230 V AC) %		85	86
MTTF H		> 400.000	> 600.000
Start-up delay s		< 1	< 1
Dielectric strength between input/output V AC		2,500 (class II)	3,000 (class II)
Dielectric strength between input/PE V AC		—	—
Ambient temperature range **** °C		-20...+60	-20...+70
Protection category		IP 20	IP 20
Approvals (according to type)		<b>CE</b>	

## Features

### Range of modular DC power supplies

- High efficiency (up to 91%)
- Low (< 0.4 W) stand-by power absorption
- Thermal protection: internal, with  $V_{out}$  shutdown
- Short circuit protection: hiccup (auto-recovery) mode
- Input protection: replaceable internal fuse plus spare
- Overvoltage protection: varistor
- Flyback topology
- ZVS (Zero-voltage-switching), quasi-resonant mode technology
- Compliant to EN 60950-1 and EN 61204-3
- Parallel working for automatic redundancy: with OR-IN diode
- Dual and series connection permissible
- Small dimensions: 70 mm (4-modules) wide, 60 mm deep
- 35 mm rail (EN 60715) mount

Screw terminal



For outline drawing see page 7

**NEW 78.60**



- 24 V DC, 60 W output
- Voltage regulation 24-28V
- ZVS technology

**NEW 78.50**



- 12 V DC, 50 W output
- Voltage regulation 12-14V
- ZVS technology

- \* (see diagrams L78)
- \*\* peak to peak, 100 Hz component, with 100 V AC input
- \*\*\* 88...100 V AC with output current 80 %  $I_N$
- \*\*\*\* (see derating diagrams P78)

Output specification		78.60	78.50
Output current (-20...+40°C, 230 V AC input)	A	2.8	4.6
Rated current $I_N$ (50°C, full input operating range)	A	2.5	4.2
Rated voltage	V	24	12
Rated power	W	60	50
Output power (-20...+40°C, 230 V AC input)	W	68	55
Peak current capability for 3 ms *	A	10	10
Output voltage adjust	V	24...28	12...14
Voltage variation (from no-load to full-load)		< 1 %	< 1 %
Voltage ripple @ full load **	mV	< 200	< 200
Hold-up time@full load: with 100 V AC input ms		< 20	< 30
	with 260 V AC input ms	< 130	< 150
Input specification		78.60	78.50
Nominal voltage ( $U_N$ )	V AC (50/60 Hz)	110...240	110...240
	V DC (not polarized)	220	220
Operating range	V AC (50/60 Hz)	100...265***	100...265***
	V DC	140...370	140...370
Max power absorption	VA	90	89
	(@ 100 V AC, 50 Hz) W	67.5	58.3
Stand-by power absorption	W	< 0.4	< 0.4
Power factor		0.75	0.65
Max current absorption (@ 88 V AC)	A	0.9	0.85
Max. inrush current (peak @ 265 V) for 3 ms	A	30	30
Replaceable protection fuse		1.6 A - T	1.6 A - T
Technical data		78.60	78.50
Efficiency (@ 230 V AC)	%	91	90
MTTF	H	> 500.000	> 400.000
Start-up delay	s	< 1	< 1
Dielectric strength between input/output	V AC	3,000 (class II)	3,000 (class II)
Dielectric strength between input/PE	V AC	1,500 (class I)	1,500 (class I)
Ambient temperature range ****	°C	-20...+70	-20...+70
Protection category		IP 20	IP 20
Approvals (according to type)		<b>CE</b>	

## Ordering information

Example: 78 series switching power supply, 36 W 24 V DC output, supply voltage 110...240 V AC, replaceable fuse.

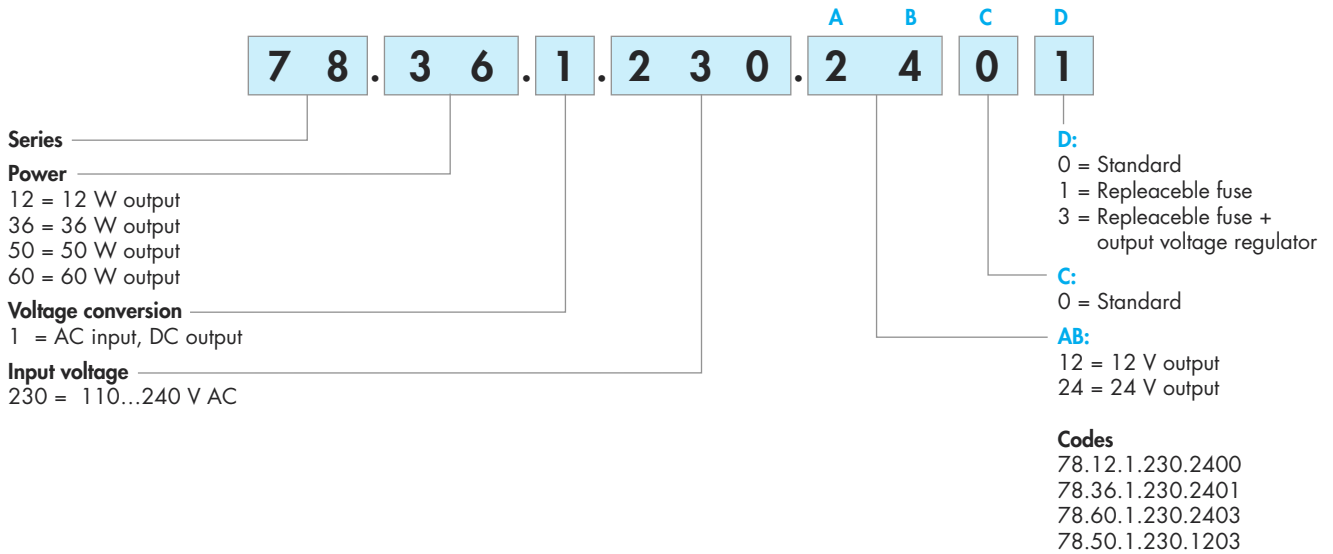

## Technical data

EMC specifications (according to EN 61204-3)		Reference standard	78.12, 78.36	78.60, 78.50
Electrostatic discharge	contact discharge	EN 61000-4-2	4 kV	4 kV
	air discharge	EN 61000-4-2	8 kV	8 kV
Radiated electromagnetic field	80 ... 1,000 MHz	EN 61000-4-3	6 V/m	10 V/m
	1 ... 2.8 GHz	EN 61000-4-3	3 V/m	3 V/m
Fast transients (burst 5/50 ns, 5 and 100 kHz)	on supply terminals	EN 61000-4-4	2 kV	3 kV
Voltage pulses on supply terminals (surge 1.2/50 µs)	common mode	EN 61000-4-5	2 kV	2 kV
	differential mode	EN 61000-4-5	2 kV (78.12), 4 kV* (78.36)	4 kV *
Radio-frequency common mode voltage (0.15...230 MHz)	on supply terminals	EN 61000-4-6	6 V	10 V
Short interruptions		EN 61000-4-11	5 cycles	6 cycles
Radio-frequency conducted emissions	0.15...30 MHz	EN 55022	class B	class A
Radiated emissions	30...1,000 MHz	EN 55022	class B	class A
<b>Terminals</b>			<b>solid cable</b>	<b>stranded cable</b>
Max. wire size		mm <sup>2</sup>	1 x 4 / 2 x 2.5	1 x 4 / 2 x 2.5
		AWG	1 x 12 / 2 x 14	1 x 12 / 2 x 14
Screw torque		Nm	0.8	
Wire strip length		mm	9	
<b>Other data</b>				
Power lost to the environment	without output current	W	0.4	
	with rated output current	W	2 (78.12), 5 (78.36, 78.50), 5.4 (78.60)	

\* input fuse blowing with surges higher than 1.5 kV

## Output specification

**L78-1 Output current v ambient temperature (78.12)**

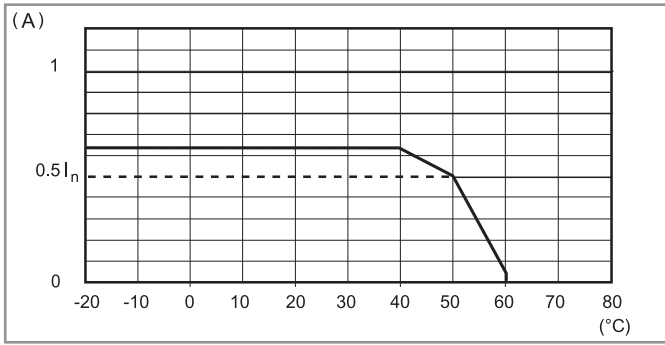

**P78-1 Output peak current v time (78.12)**

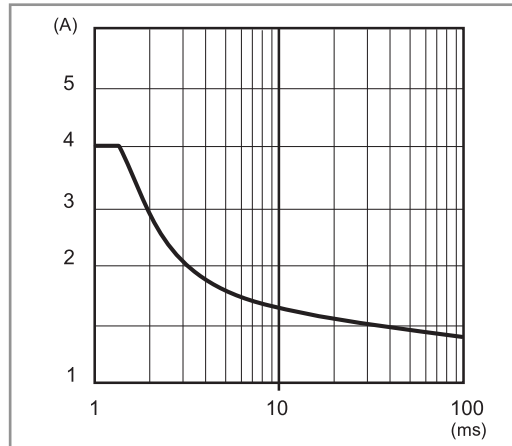

**L78-2 Output current v ambient temperature (78.36)**

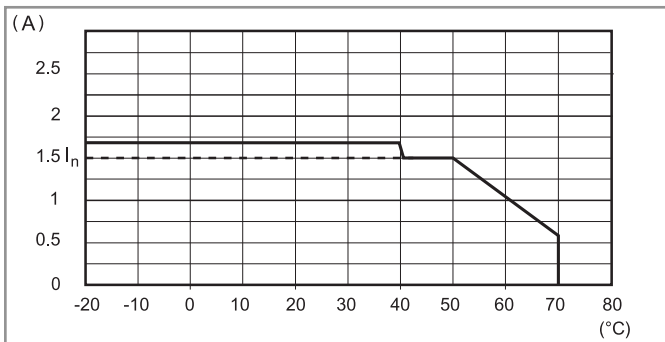

**P78-2 Output peak current v time (78.36)**

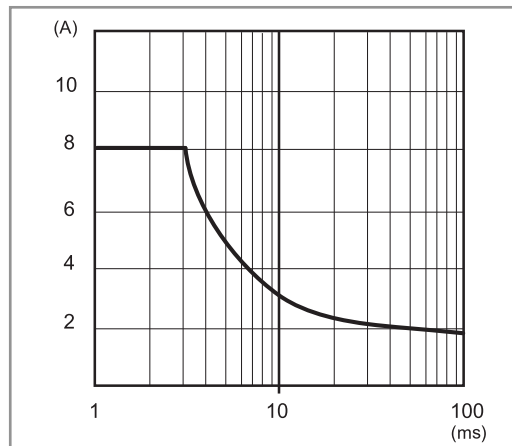

**L78-3 Output current v ambient temperature (78.60)**

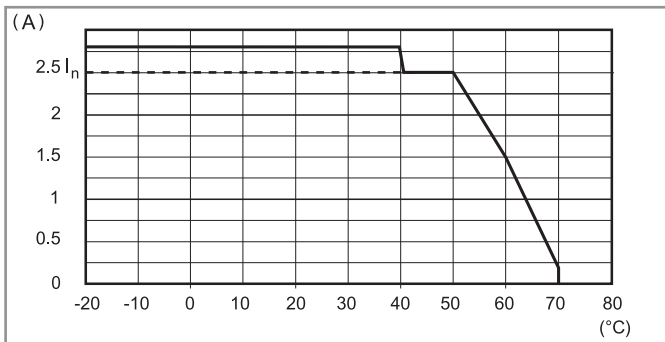

**P78-3 Output peak current v time (78.60)**

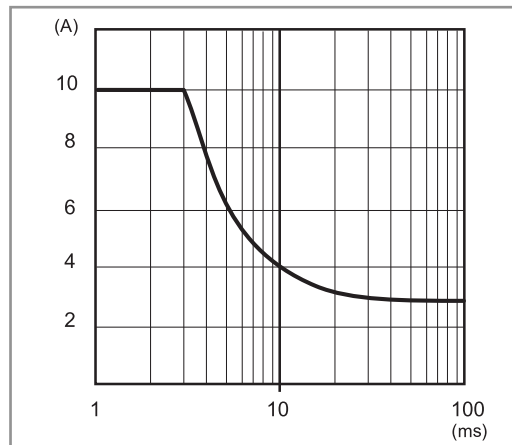

**L78-4 Output current v ambient temperature (78.50)**

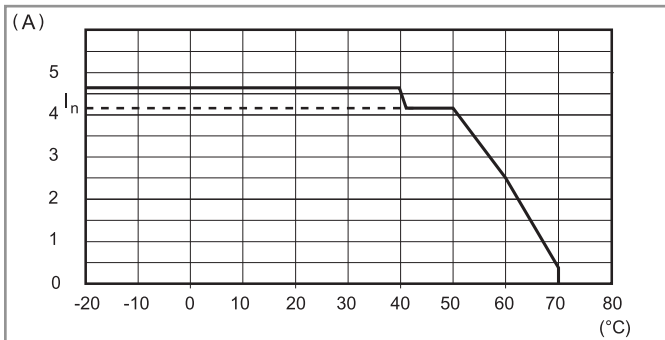

**P78-4 Output peak current v time (78.50)**

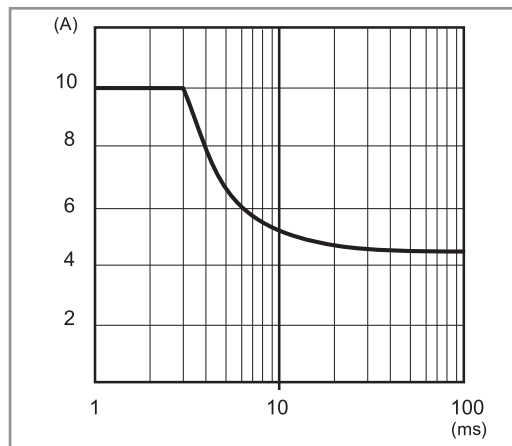

## Hiccup mode

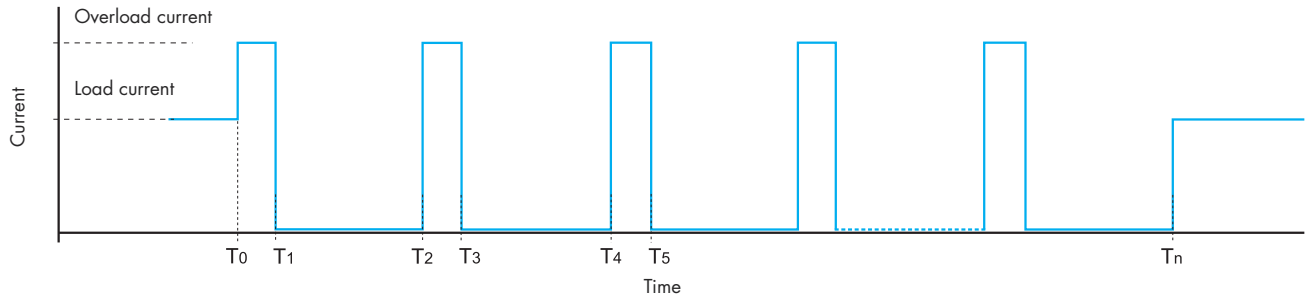

Under normal conditions, the 78 Series Power Supply supplies the current required by the load. However, under abnormal conditions such as a short circuit or heavy overload ( $T_0$ ) the output voltage will be rapidly reduced to zero - followed by the current ( $T_1$ ). After approximately 2 seconds ( $T_1$  to  $T_2$ ), the power supply checks for the persistence of the anomaly over the time period  $T_2$  to  $T_3$  (30 to 100ms - dependent on the type of anomaly). If the anomaly persists, as shown above, the current is again reset to 0 A for a further 2 s ( $T_3$  to  $T_4$ ). This "hiccup" process is repeated until the anomaly is removed ( $T_n$ ), whereon the power supply then returns to normal working.

## Wiring diagrams

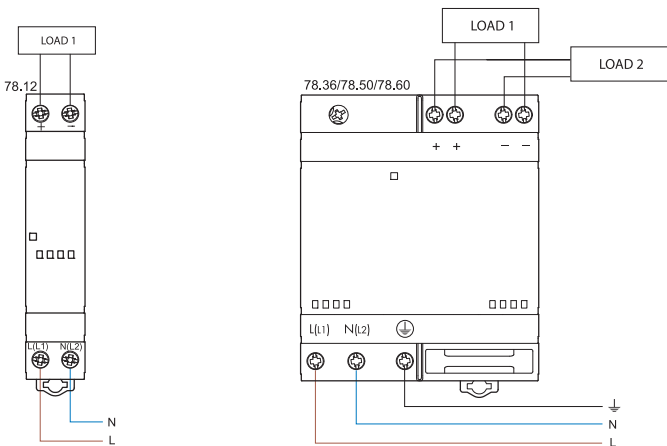

Dual connection

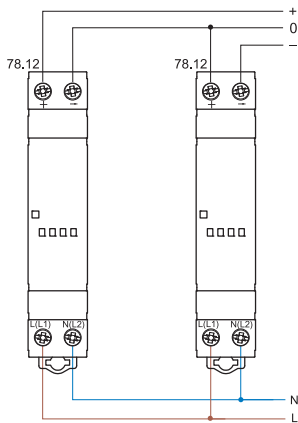

Dual connection

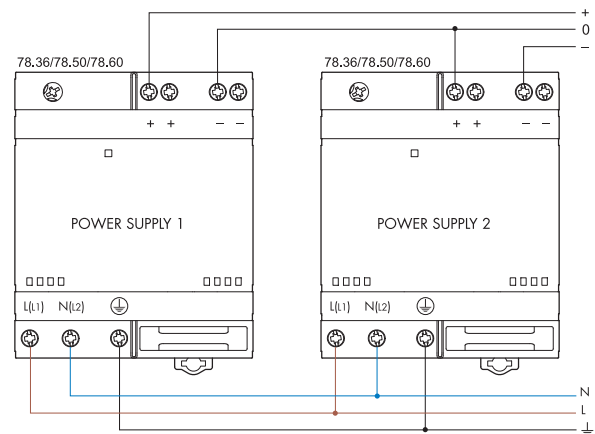

Series connection

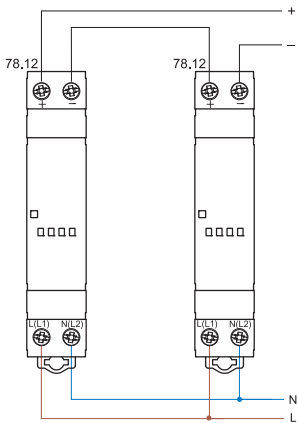

Series connection

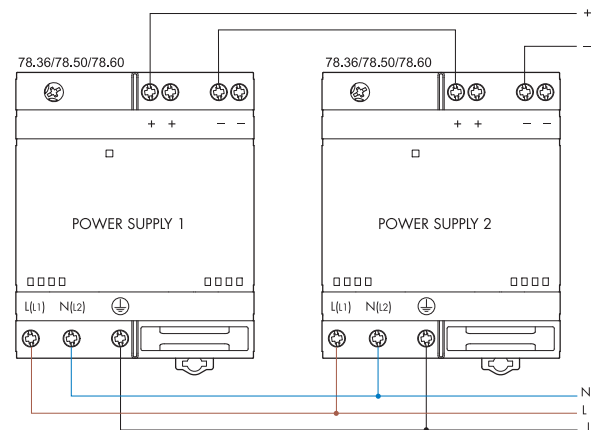

## Application example: redundancy connection

Manual

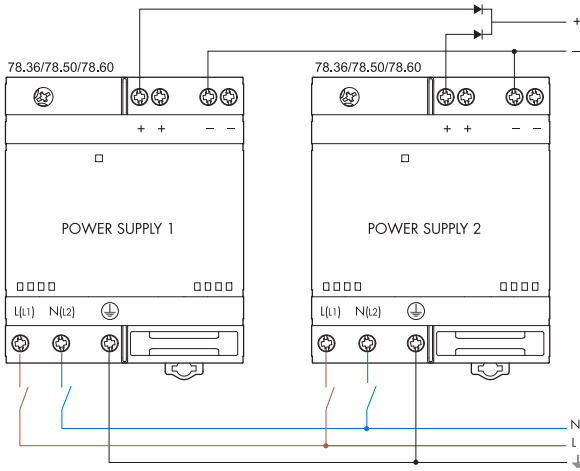

Automatic (with parallel connection)

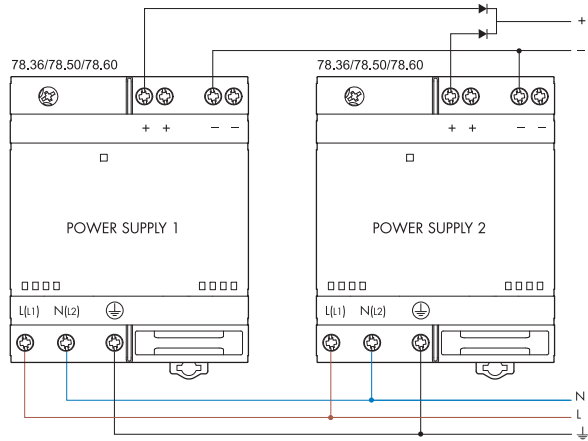

**Note:** Since parallel working is intended to provide automatic redundancy, rate the output current at no more than  $I_n$ .

## Diode(s)

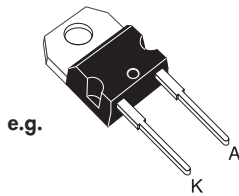
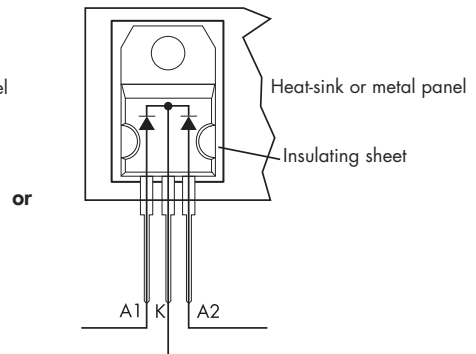
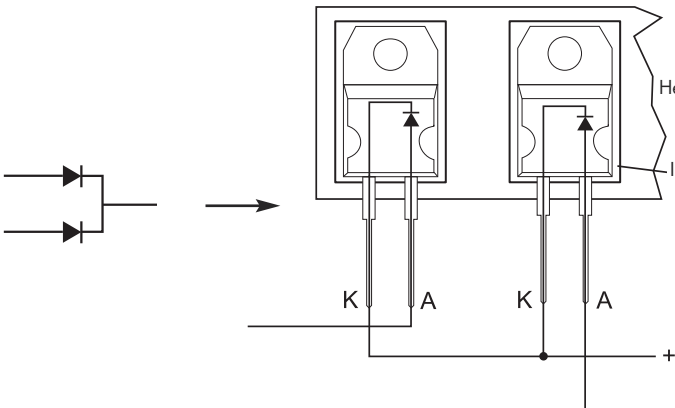

**TO-220AC  
STPS1545D**

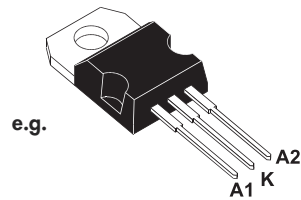

**TO-220AB  
STPS30L40CT**

## Outline drawings

78.12  
Screw terminal

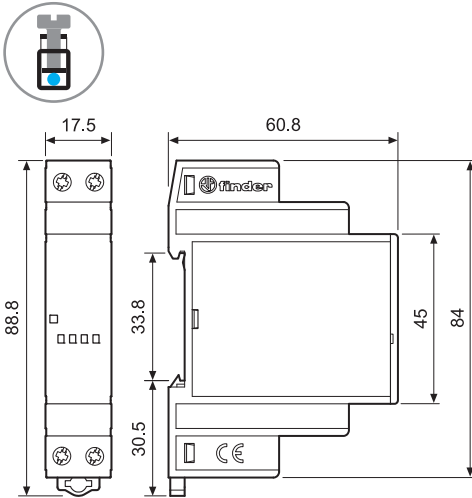

78.36  
Screw terminal

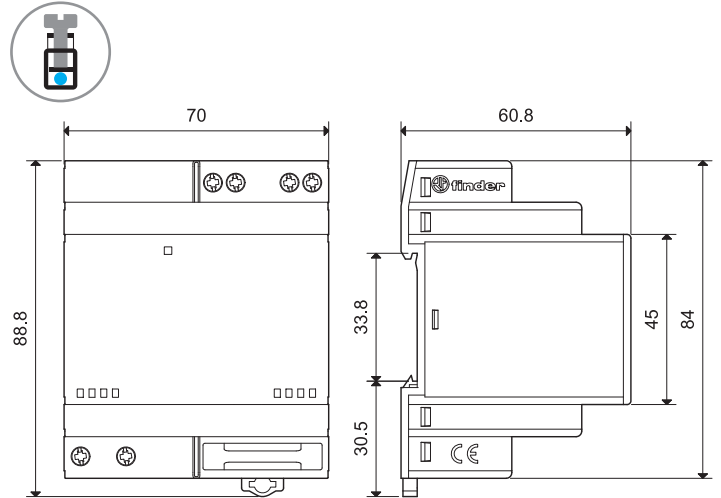

78.50 / 78.60  
Screw terminal

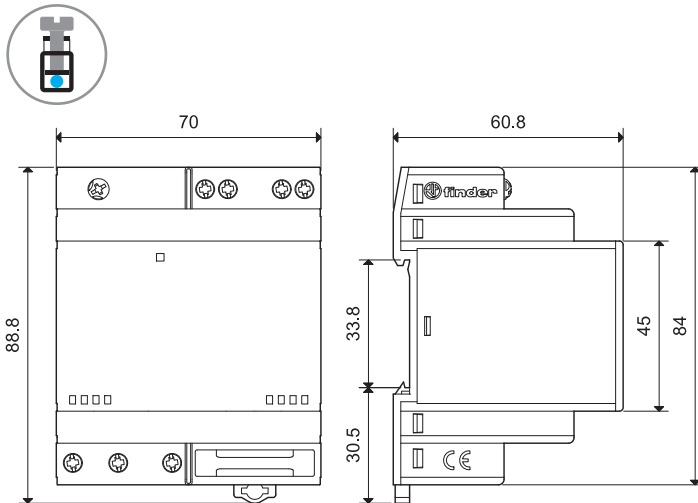

## Accessories

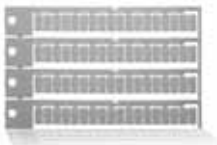

Sheet of marker tags, plastic, 72 tags, 6x12 mm

060.72

060.72



Identification tag, plastic, 1 tag, 17x25.5 mm

019.01

019.01

