













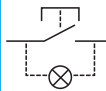
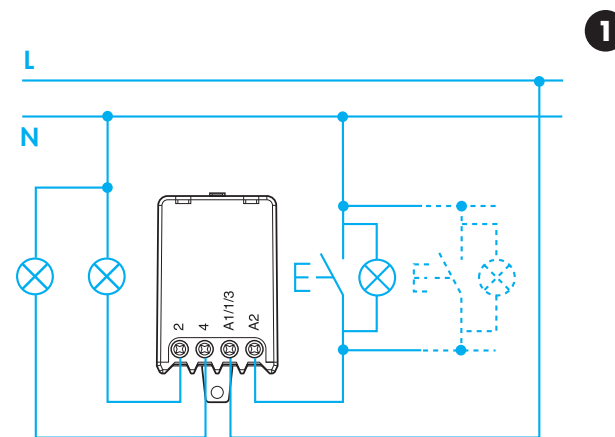

A		U_N 230 V AC (50 Hz) U_{min} : 184 V AC U_{max} : 253 V AC
		27.21 1 NO (SPST-NO) 10 A 230 V AC 27.25/27.26 2 NO (DPST-NO) 10 A 230 V AC
		AC1 2300 VA AC15 (230V AC) 500 VA
		 (230V AC) 1000 W  (230V AC) 360 W
		(-40...+40)°C
		15 (1mA)
IP 20		



2

	počet krokov	postup krokov			
		1	2	3	4
27.21	2				
27.25	4				
27.26	3				

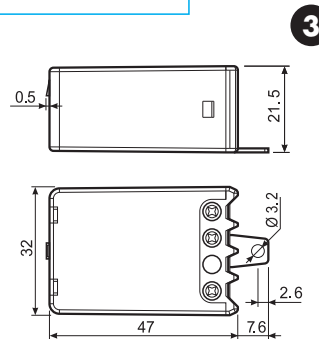

- 1** Schéma pripojenia
- 2** Postup krokov
- 3** Rozmery