

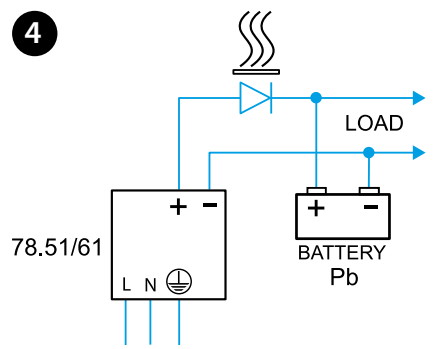

78

| | |
|------|---|
| IN | 78.xx.1.230.xxxx U _N (110...240)V AC (50/60 Hz) U _N 220 V DC |
| | 78.36 U _{min} - U _{max} (100-265)V AC (88-100)V AC (I _{OUT} = 80% I _N) U _{min} - U _{max} (140-370)V DC |
| | 78.5x/6x U _{min} - U _{max} (88-265)V AC U _{min} - U _{max} (140-370)V DC |
| OUT | 78.36.1.230.2401 - [IN (230 V AC) / (-20...+40)°C] 1.7 A (max 8 A - 3 ms) 24 V DC, 40 W - [IN (100...265)V AC - (140...370)V DC / (+50)°C] 1.5 A (max 8 A - 3 ms) 24 V DC, 36 W |
| | 78.5x.1.230.1203 - [IN (230 V AC) / (-20...+40)°C] 4.6 A (max 12 A - 3 ms) 12 V DC, 55 W - [IN (100...265)V AC - (140...370)V DC / (+50)°C] 4.2 A (max 12 A - 3 ms) 12 V DC, 50 W |
| | 78.6x.1.230.2403 - [IN (230 V AC) / (-20...+40)°C] 2.8 A (max 10 A - 3 ms) 24 V DC, 68 W (78.60) 2.6 A (max 8 A - 3 ms) 24 V DC, 68 W (78.61) - [IN (100...265)V AC - (140...370)V DC / (+50)°C] 2.5 A (max 10 A - 3 ms) 24 V DC, 60 W (78.60) 2.5 A (max 8 A - 3 ms) 24 V DC, 60 W (78.61) |
| | (-20...+70)°C |
| IP20 | |

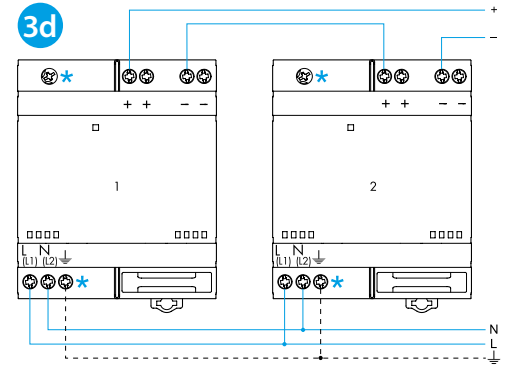
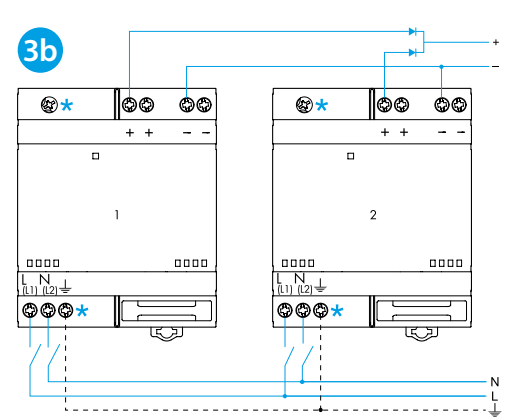
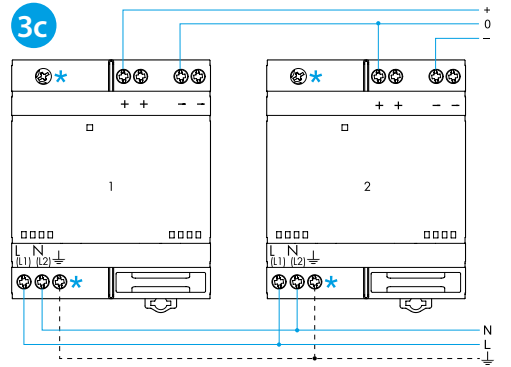
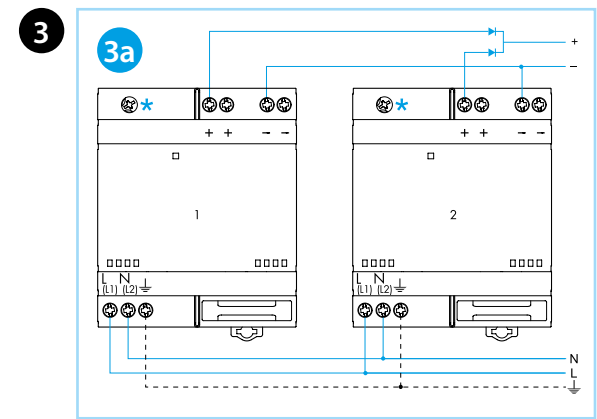
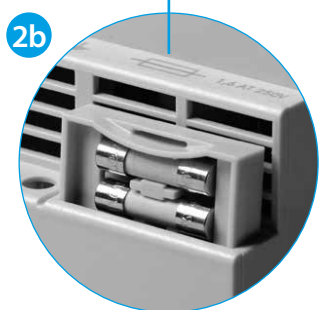
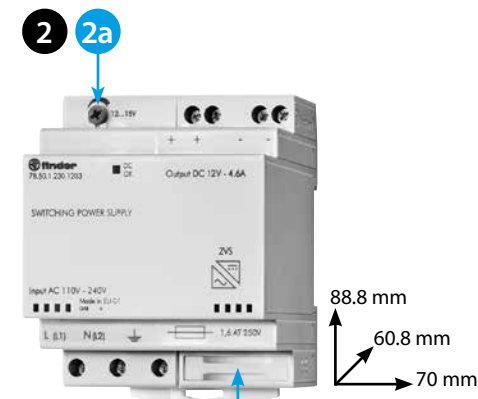
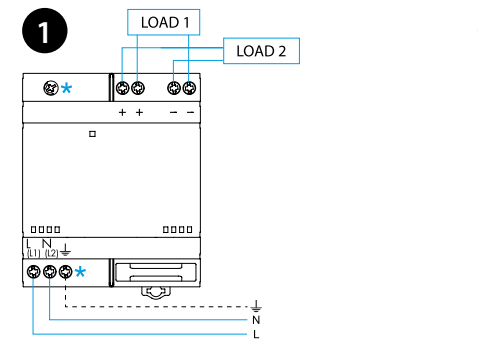
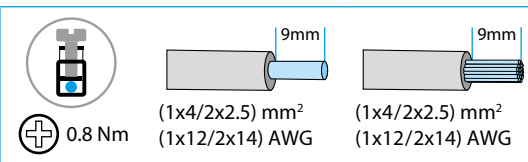

| | | | |
|---|-----|---|-----|
| 5 | 78 | U | LED |
| | OK | ✓ | |
| | Sh | ✓ | |
| | ThL | ✓ | OFF |

- 5 LED
- U AC/DC Supply
- Sh Short circuit
- ThL Thermal limit

ENGLISH

SWITCH MODE POWER SUPPLIES

- 1 CONNECTIONS
- * not for 78.36

- 2a Output voltage regulator (78.5x/6x)
- 2b Fuse box (internal fuse plus spare)
- 78.36: 1 A - T fuse
- 78.5x/6x: 1.6 A - T fuse

- 3 WIRING DIAGRAM EXAMPLES
- 3a Automatic redundancy (I: ≤ 2 x I_N) (78.51/61)
- 3b Manual redundancy (I: ≤ I_N)
- 3c Dual connection-for a Bipolar supply (+24/-24)
- 3d Series connection-for increased output voltage
- * not for 78.36

- NOTE
- The output voltage regulation has to be done preferably with a load connected. The voltage regulation must be done slowly (78.5x/6x)
- 78.5x: V_{OUT} 12...15 DC
- 78.6x: V_{OUT} 24...28 DC
- 78.36: efficiency (@230 V AC) 86%
- 78.5x: efficiency (@230 V AC) 90%
- 78.6x: efficiency (@230 V AC) 91%

Fold-back mode (78.51/61)
If connected as wiring diagram 3a, two parallel connected power supplies can deliver up to:
110 W / 9.2 A (2x78.51)
125 W / 5.2 A (2x78.61)
In case of moderate overload, the fold-back characteristic reduces the nominal output voltage without the power supply entering its full protection mode.
When the overload is removed the power supply returns to its normal operating mode.
The fold-back characteristic allows the 78.51/61 to be used as a battery charger, in particular for charging lead batteries in the range 7...24 Ah. It is suggested to connect a diode between the power supply Output + (diode Anode) and to the Battery + (diode Cathode) - if not already integral with the battery.

